

# ProTek Systems, Inc.

PROTEK SYSTEMS, INC.  
1250 WALLACE DR UNIT B  
DELRAY BEACH, FL 33444  
TELEPHONE: 800-598-2153  
FAX: 561-395-4771  
SALES@PROTEKMAIL.COM

## CGAD-60 ALUMINUM DIAMOND PLATE CORNER GUARD

### FEATURES:

- $\frac{1}{8}$ " THICK GRADE 3003 BRIGHT FINISH ALUMINUM DIAMOND PLATE
- STOCK LENGTHS: 4FT, 8FT, OR 10FT
- CUSTOM WING SIZES AVAILABLE
- CUSTOM HEIGHTS AND ANGLES AVAILABLE
- OTHER FINISHES AVAILABLE

### MOUNTING OPTIONS:

- ADHESIVE:
  - ADH-50 CONSTRUCTION ADHESIVE (SUPPLIED SEPARATELY AS REQUIRED)
- DRILLED:
  - CLEARANCE HOLES FOR #8 FASTENER ABSS-11 #8 X  $1\frac{1}{2}$ " OVAL HEAD SHEET METAL SCREW AND ABCW-132 STAINLESS CUP WASHER (FASTENERS BY OTHERS)
  - STANDARD SPACING: 3" FROM EACH END AND SPACED EVENLY NOT TO EXCEED 36" O.C.

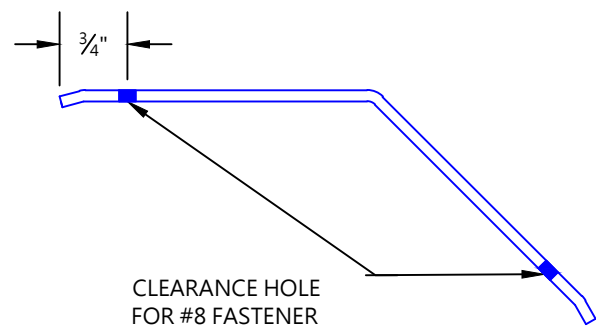
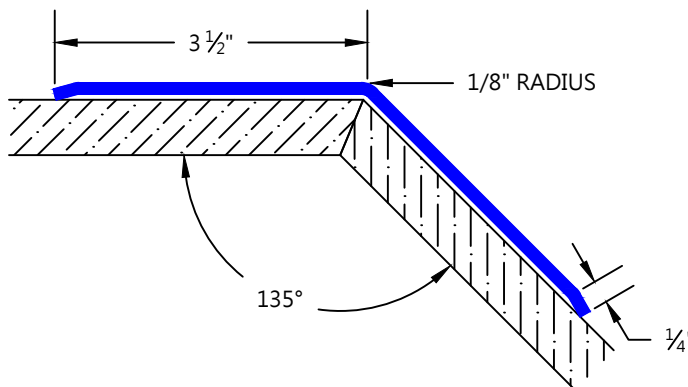
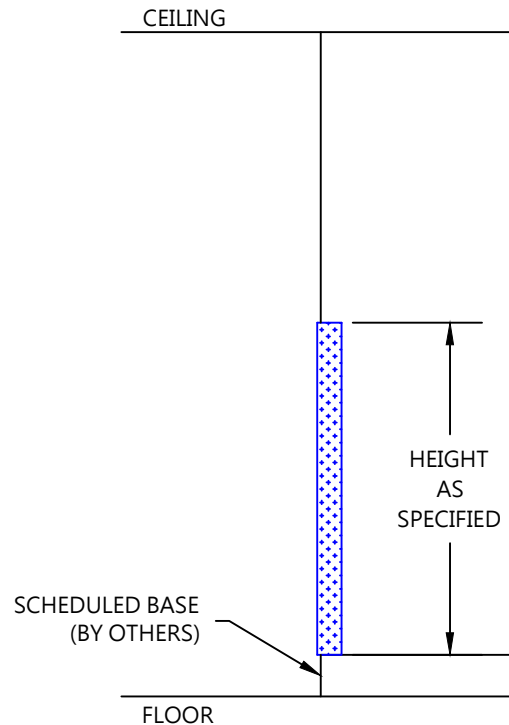

CUSTOMER:

PROJECT:

ARCHITECT:

SALES REP:

**CGAD-60**