

# ProTek Systems, Inc.

PROTEK SYSTEMS, INC.  
2799 N.W. 2ND AVE  
BOCA RATON, FL 33431  
TELEPHONE: 800-598-2153  
FAX: 561-395-4771  
SALES@PROTEKMAIL.COM

## PHOTO CGD-401 DECORATIVE PHOTO CORNER GUARD

### FEATURES:

- ALLOY 5052-H32 .080" THICK ALUMINUM WITH POWDER COATED PHOTO FINISH
- STOCK LENGTHS: 4FT OR 8FT
- CUSTOM WING SIZES AVAILABLE
- CUSTOM HEIGHTS AND ANGLES AVAILABLE

### MOUNTING OPTIONS:

- ADHESIVE:
  - ADH-50 CONSTRUCTION ADHESIVE (SUPPLIED SEPARATELY AS REQUIRED)
- DRILLED:
  - CLEARANCE HOLES FOR #8 FASTENER ABSS-11 #8 X 1 1/2" OVAL HEAD SHEET METAL SCREW AND ABCW-132 STAINLESS CUP WASHER (FASTENERS BY OTHERS).
  - STANDARD SPACING: 3" FROM EACH END AND SPACED EVENLY NOT TO EXCEED 36" O.C.

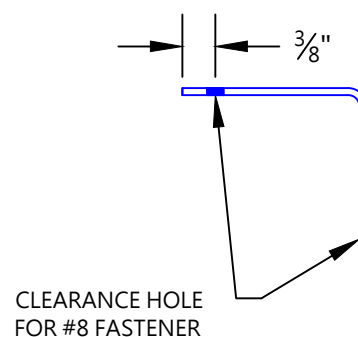
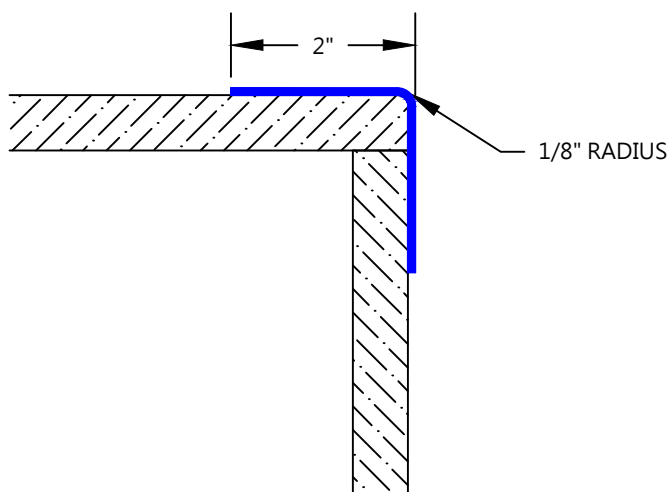
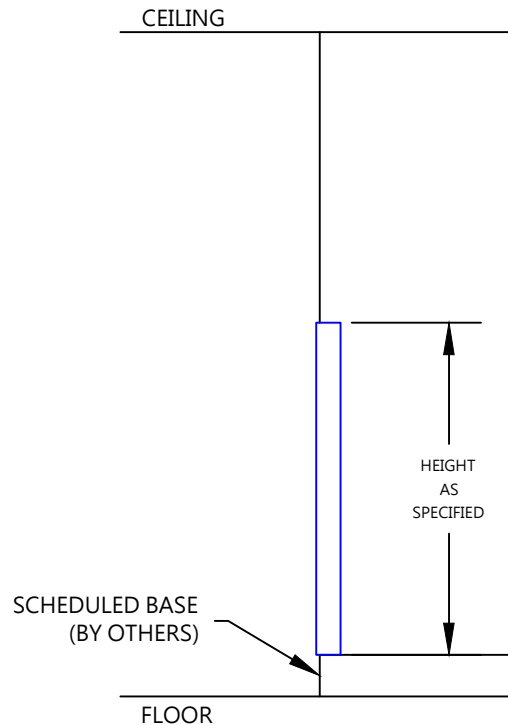

REV. 10/15/2012

CUSTOMER:

PROJECT:

ARCHITECT:

SALES REP:

PHOTO CGD-401